

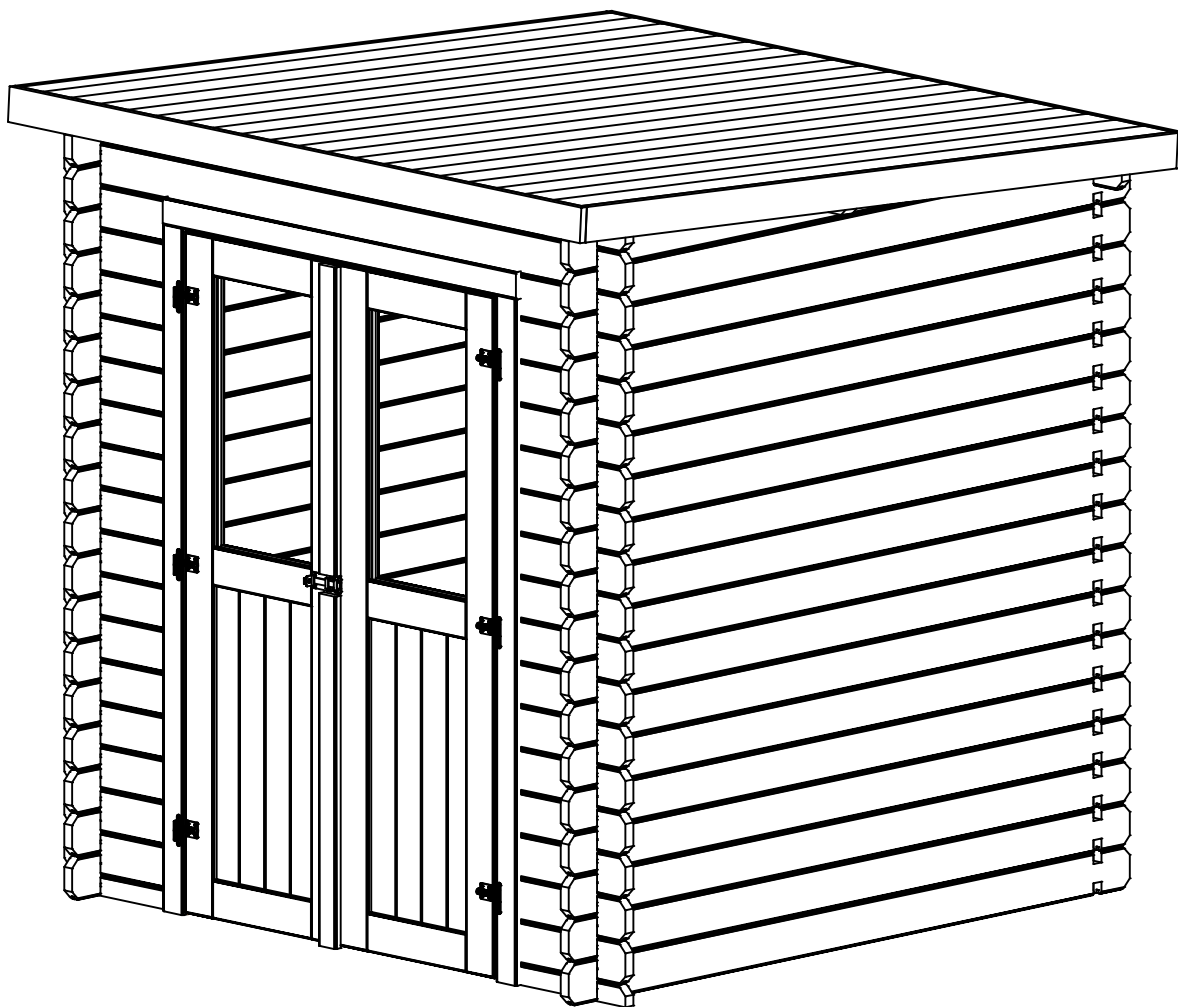









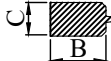
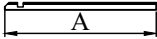

MONTAGEANLEITUNG
G231228M
2.30 x 1.18 m, 28mm



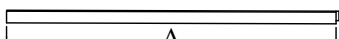
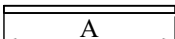

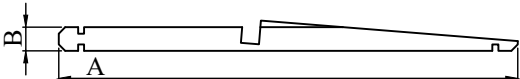

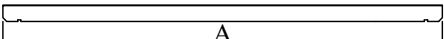
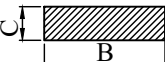
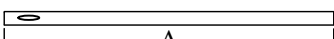
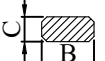
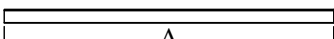
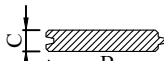
STÜCKLISTE

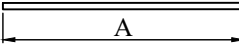
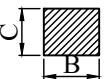
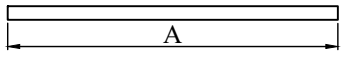
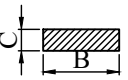
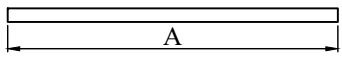
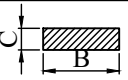
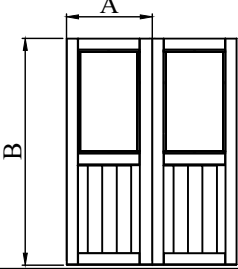
No.	Menge	Abmessungen, mm			Teile	
		A	B	C		
1a	x 1	2300	55	28		
1b	x 2	550	55	28		
2a	x 19+1	2300	110	28		
2b	x 34+1	1180	110	28		
3	x 32	550	110	28		
4a	x 1	1314	90	66		
4b	x 1+1	1785	90	66		
4c	x 1	1110	30	30		
5	x 2	1180	110/52	28		
6	x 2	487	76/21	28		
7	x 1	2300	95	40		
8a	x 2	1980	40	16		
8b	x 2	1870	40	16		
9	x26(+2)	1280	90	17		

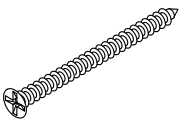
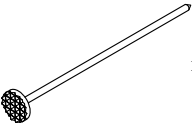
STÜCKLISTE

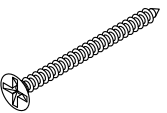
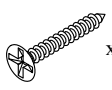
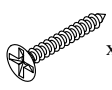
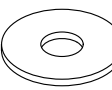
No.	Menge	Abmessungen, mm			Teile	
		A	B	C		
10	x 2	2300	30	30		
11	x 2	2340	90	19		
12	x 2	1280	90	19		
13	x 1	1740	75	19		
D	x 1+1	560	1740	30		

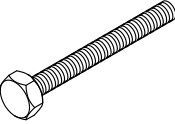
	5 x 70 mm	2 x 40 mm	M6
	 x 16	 x 90	 x 4
4 x 40mm	3 x 25 mm	4 x 30 mm	M6
 x 36	 x 8	 x 40	 x 8
	WOS 70	15x57+40x40BZN	6 x 60
	 x 1	 x 6	 x 4

Montage der Wände

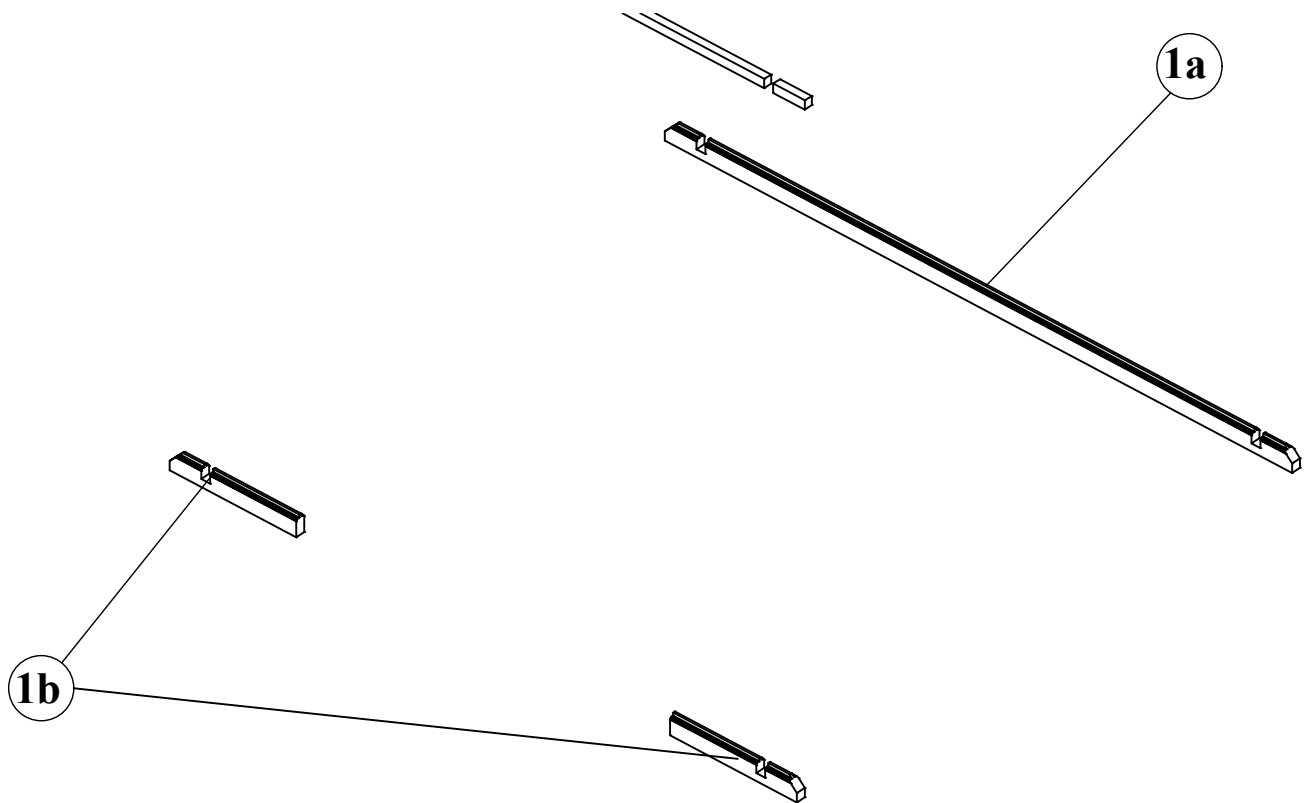

No.	Abmessungen (mm)	Menge
1a	2300 x 55 x 28	1
1b	550 x 55 x 28	2

Montage der Wände

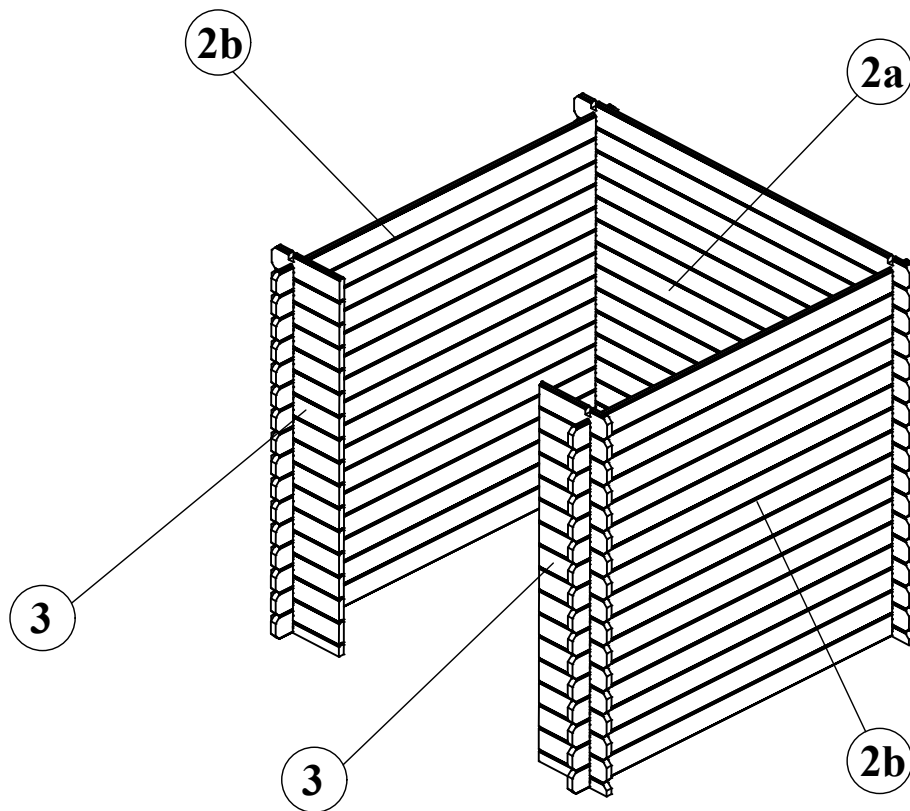

No.	Abmessungen (mm)	Menge
2a	2300 x 110 x 28	17+1
2b	1180 x 110 x 28	34+1
3	550 x 110 x 28	32

Aufsetzen von Gievvölbe und Türrahmes

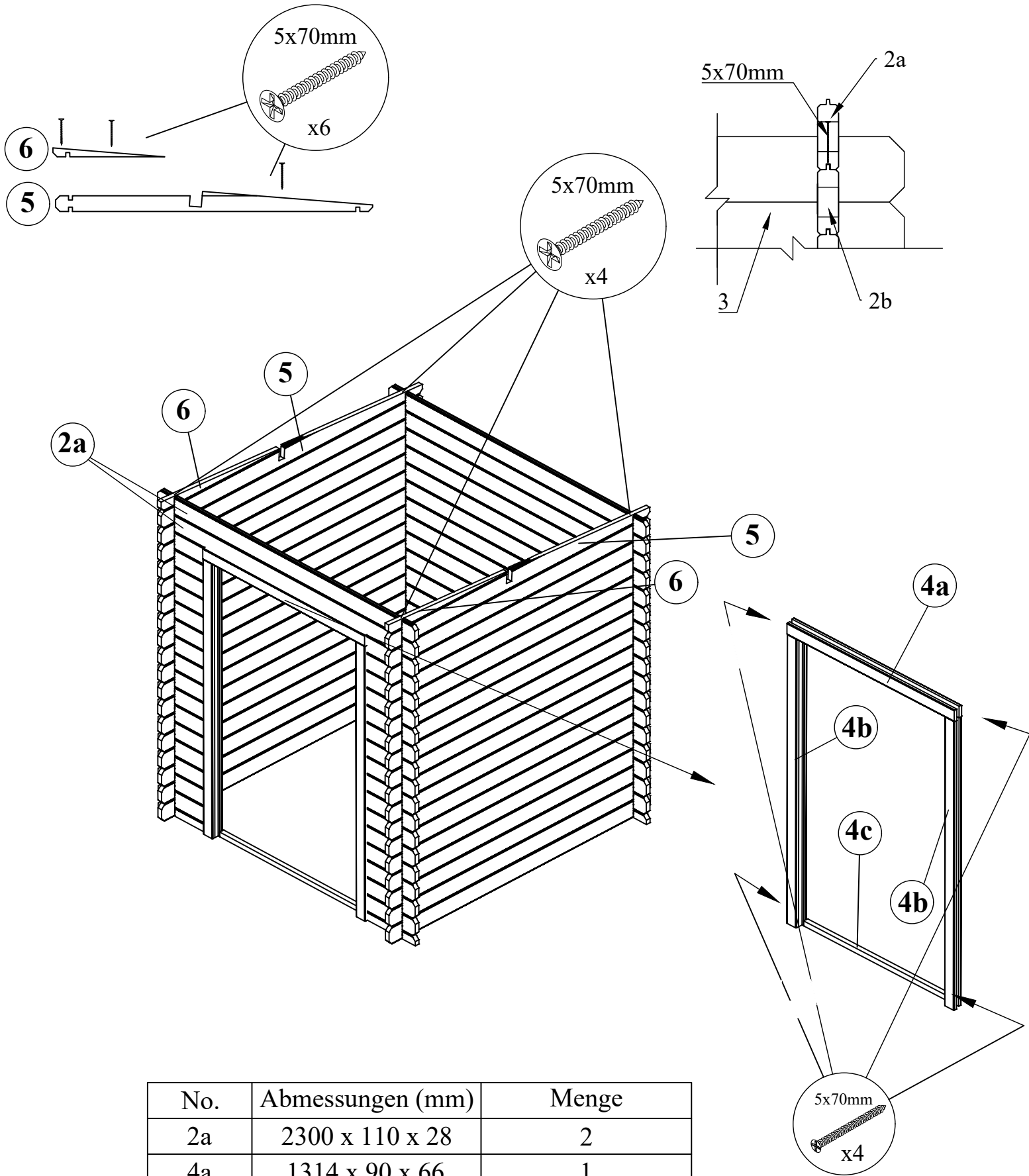

Aufsetzen von Dachsparren

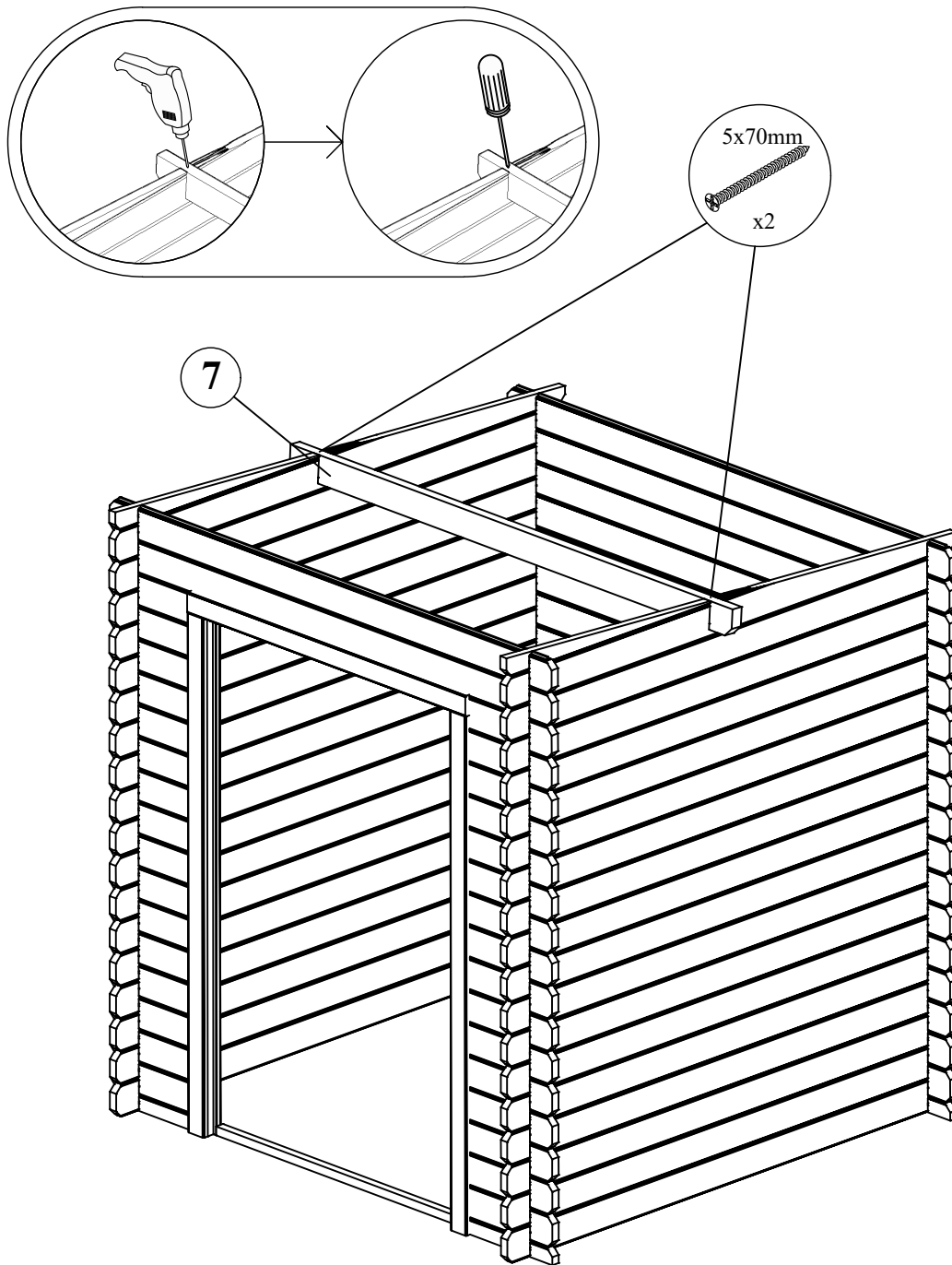

No.	Abmessungen (mm)	Menge
7	2300 x 95 x 40	1

Die Installation der Sturmflut Streifen

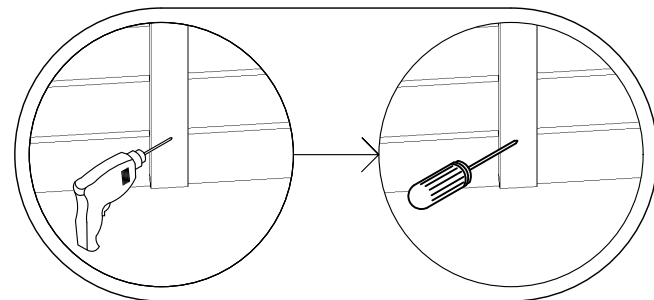
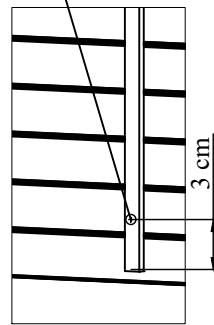
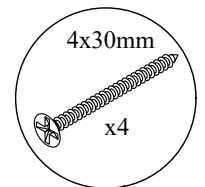
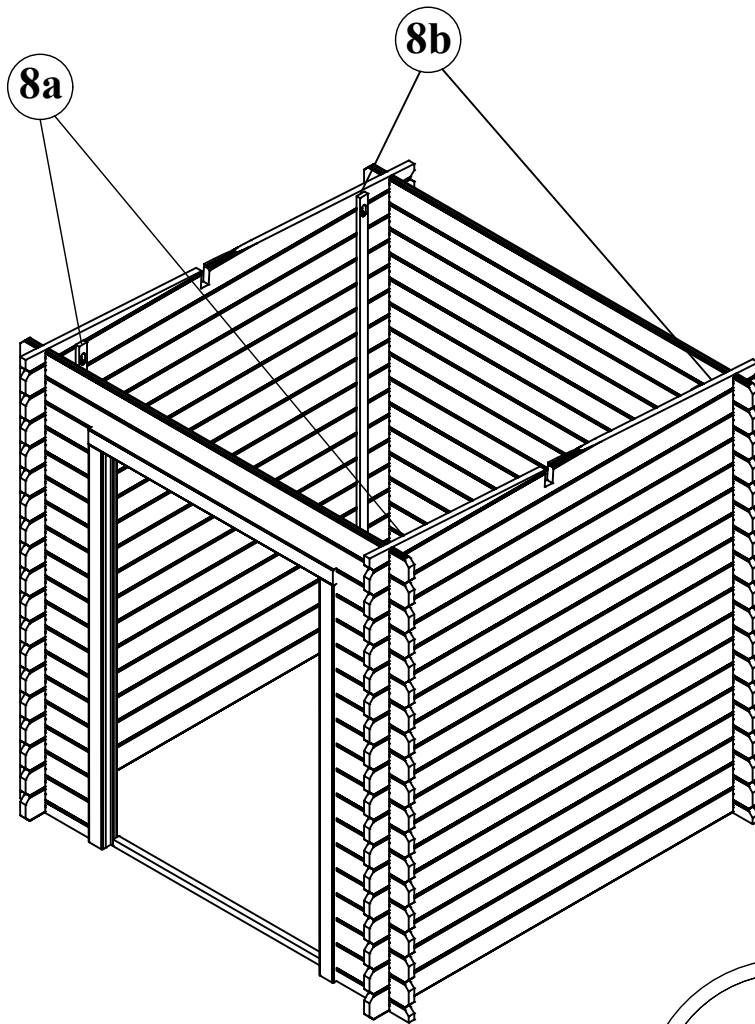
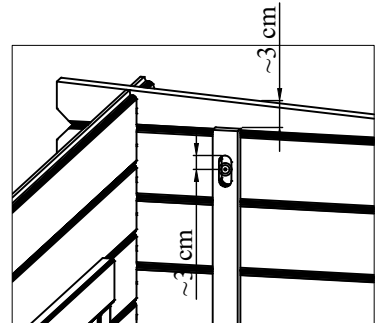
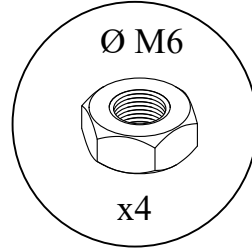
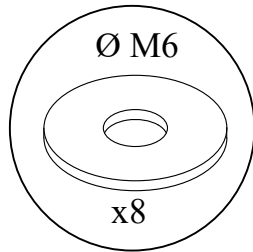
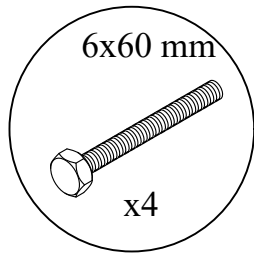

No.	Abmessungen (mm)	Menge
8a	1980 x 40 x 16	2
8b	1870 x 40 x 16	2

Dachlattung

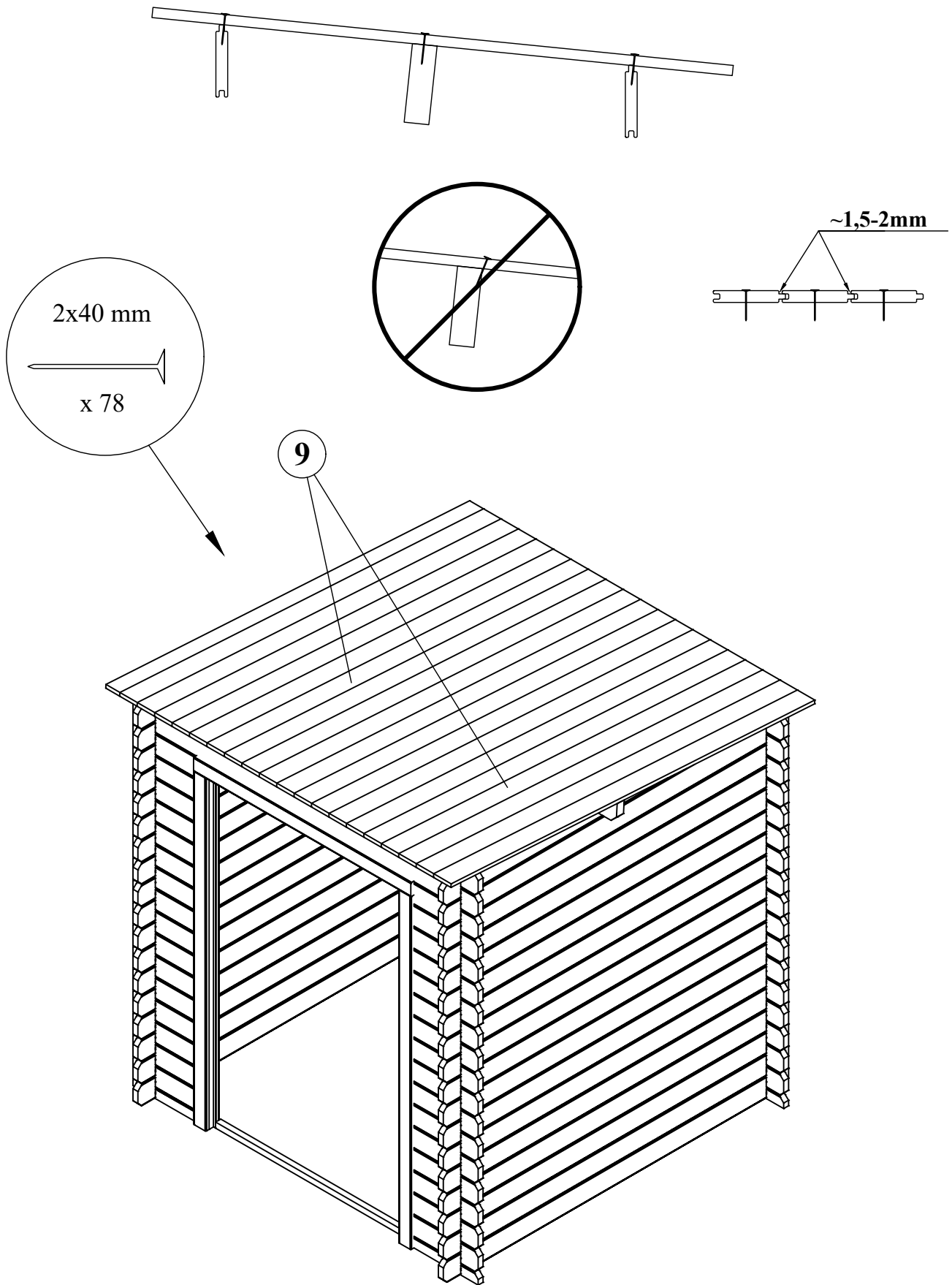

No.	Abmessungen (mm)	Menge
9	1280 x 90 x 17	26 (+2)

Dacheindeckung

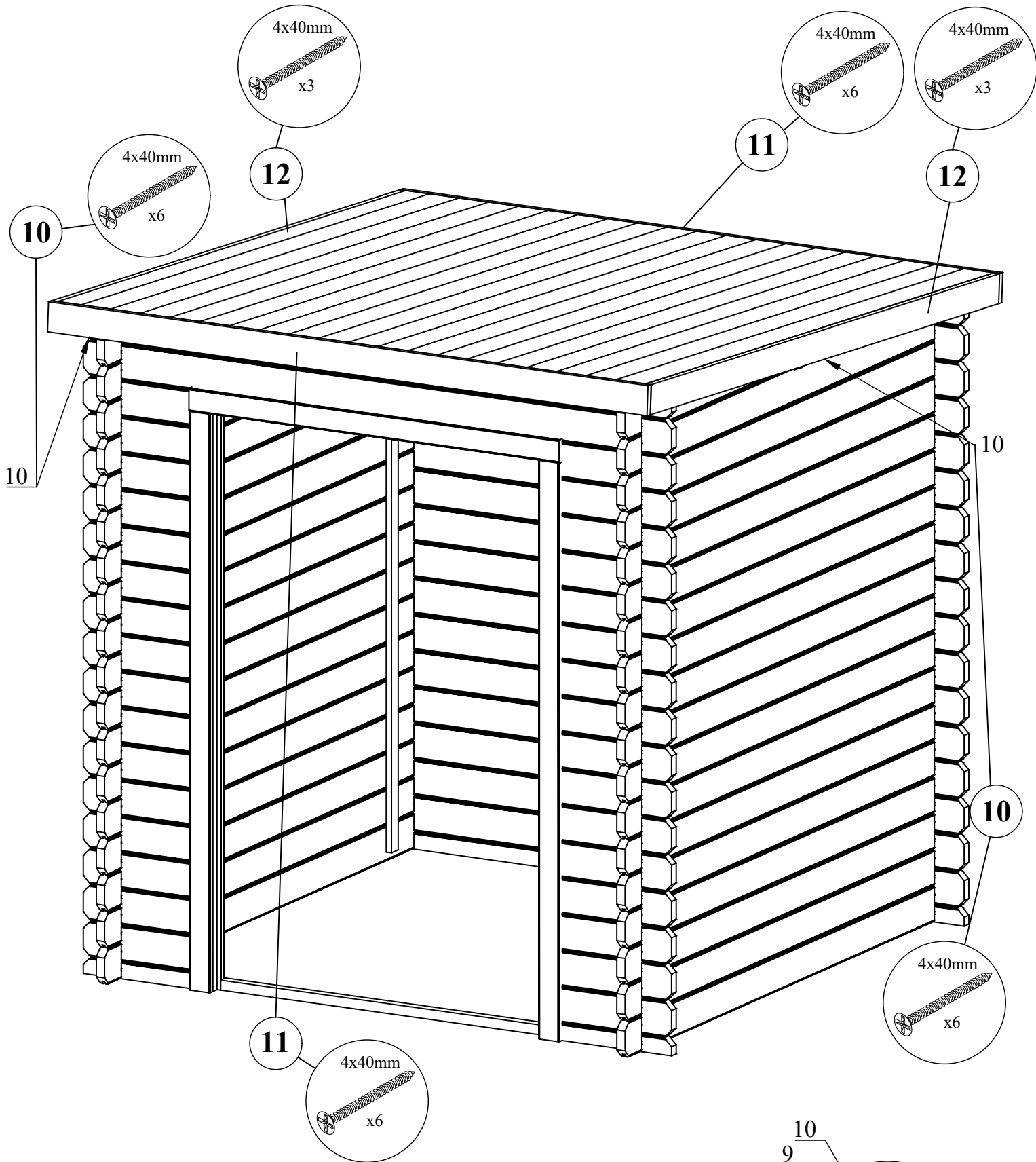

No.	Abmessungen (mm)	Menge
10	2300 x 30 x 30	2
11	2340 x 90 x 19	2
12	1280 x 90 x 19	2

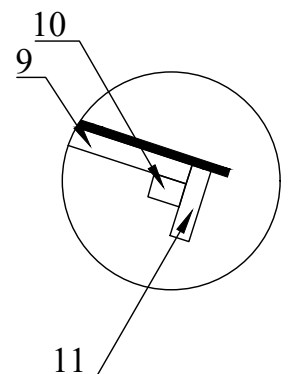

Der Einbau der Tür

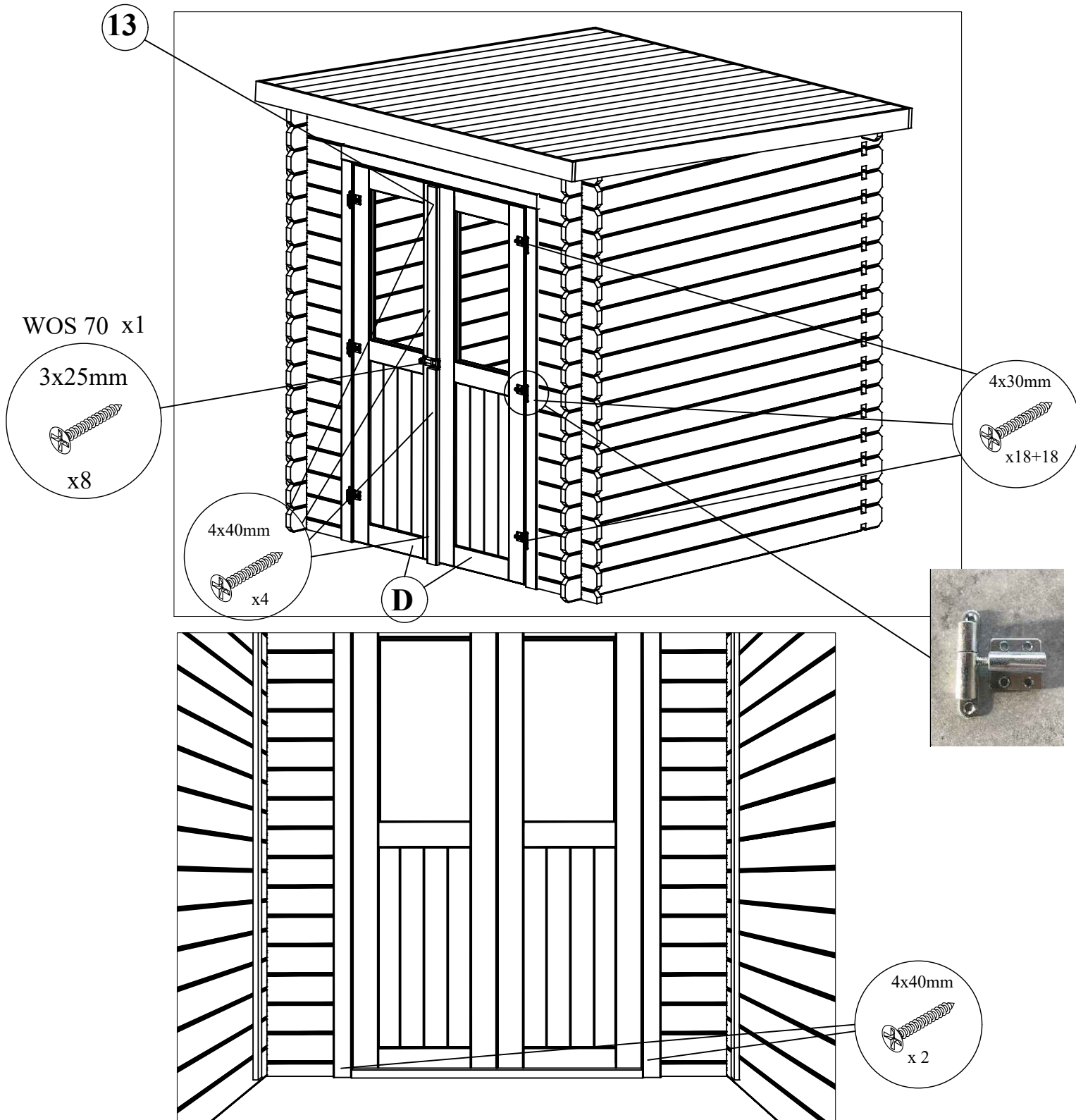

No.	Abmessungen (mm)	Menge
13	1740 x 75 x 19	1
D	1740 x 560	1 + 1

Montage des Türbeschlages

